



watch



automobile



aerospace



medical



industry



TOOL HOLDERS STAR MICRONICS.



Made in Switzerland
since 1969

PCM WILLEN SA

For over 40 years, PCM Willen SA is one of the world's leading manufacturers of special tool holders for automatic lathes. All our products are developed and manufactured in Switzerland and bear the label «Swiss Made», which is synonymous with precision, quality and reliability.

Our company is located in the middle of French-speaking part of Switzerland at the edge of Lake Geneva near Montreux. Our international dealer network ensures continued after sales support. We offer training courses, which we tailor to individual customer requirements.

PCM stays for innovation and progress. Our superbly qualified engineering staff ensures finest quality of manufacturing solutions and keeps our customers ahead of the competition.

In close cooperation with machine builders and end users, we stay on the way to satisfied customers. We will keep this track in the future.

The best quality toolholders can only provide optimum performance if they are maintained or repaired with first class replacement parts. PCM experts emphasize professional after sale support for all PCM equipment.



YOUR CHOISE N°1 IN TOOLING SYSTEMS

- Long service life ←
- Very gentle transmission even at high speed operation ←
- 100% tested ←
- Customised tool available ←

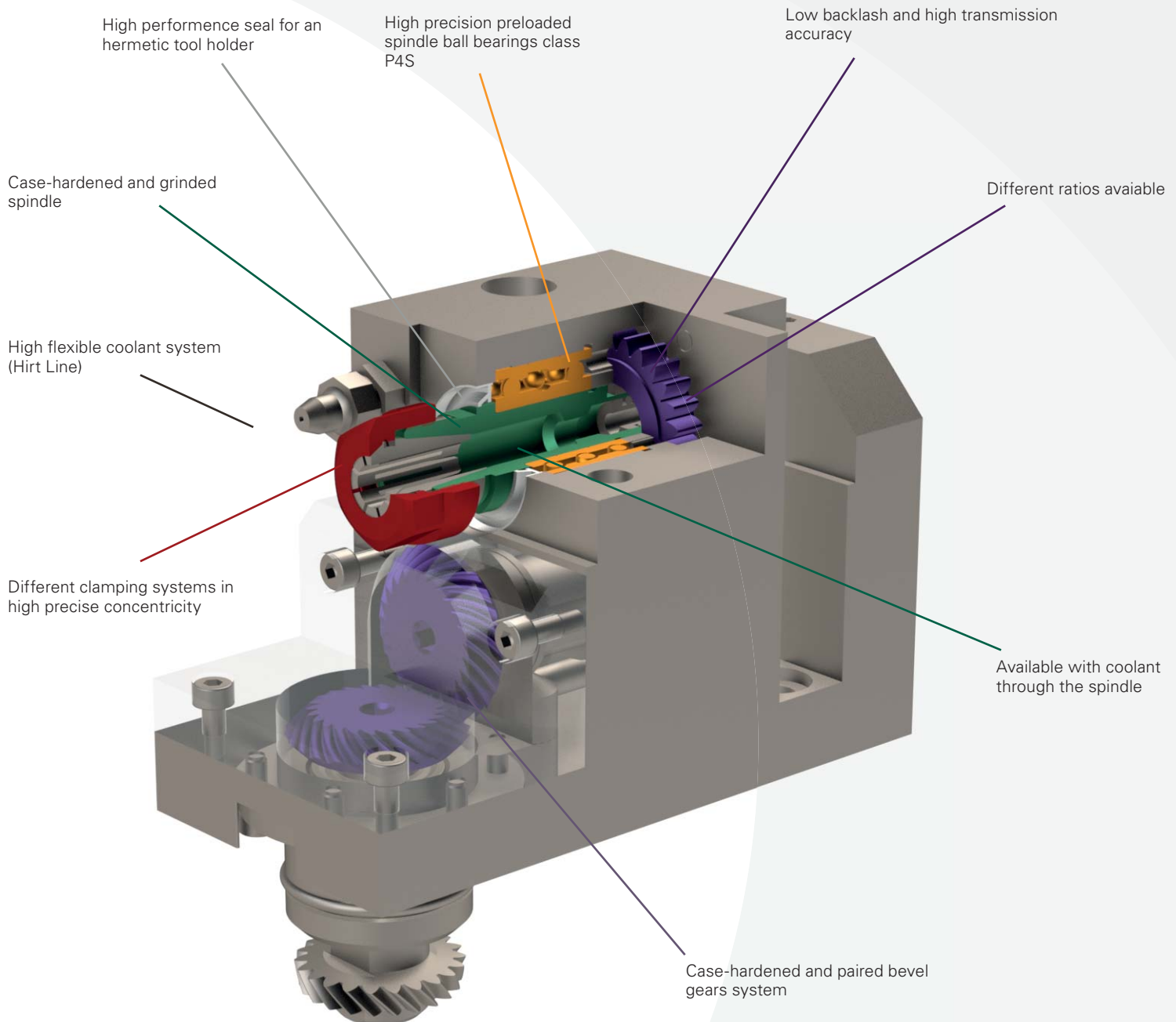

TABLE OF CONTENTS



STARMICRONICS ECAS20	6
STARMICRONICS SR10J	10
STARMICRONICS SR20J	14
STARMICRONICS SR32J	18
STARMICRONICS SV20	20
STARMICRONICS SV32	24
STARMICRONICS QUICK CHANGE	26

STAR MICRONICS

- ECAS 20



E20C-110-IK

 INT

	ER16
	-
	1:1
RPM max.	6'000
Bemerkung / Remarque / Note :	
-	



E20C-901-AR

 I+E

	3xØ32
	-
	-
RPM max.	-
Bemerkung / Remarque / Note :	
-	



E20C-110-K



 EXT

	ER16
	-
	1:1
RPM max.	6'000
Bemerkung / Remarque / Note :	
-	

E20-DE-1111



	2xER11
	-
	1:1
RPM max.	6'000
Bemerkung / Remarque / Note :	
-	

Kühlung / Arrosage / Cooling:  INT Intern / Intérieur / Interior  EXT Extern / Externe / Exterior  Ohne / Sans / Without

E20-DS-2222



	2xER11
	-
	1:2
RPM max.	12'000
Bemerkung / Remarque / Note :	
-	

E20-GSC-110



	ER16
	-
	1:1
RPM max.	6'000
Bemerkung / Remarque / Note :	
-	

E20-GSC-3X



	ER11
	-
	1:2.59
RPM max.	15'540
Bemerkung / Remarque / Note :	
-	

E20-GSE-110



	ER16
	-
	1:1
RPM max.	6'000
Bemerkung / Remarque / Note :	
-	

Kühlung / Arrosage / Cooling: INT Intern / Intérieur / Interior EXT Extern / Externe / Exterior Ohne / Sans / Without

E20-GSE-210





	2xER16
	-
	1:1
RPM max.	6'000

Bemerkung / Remarque / Note :

-

E20-RSH-080



	-
	Ø8mm
	1:1
RPM max.	6'000

Bemerkung / Remarque / Note :

Adjustable $\pm 5^\circ$

E20-RSH-035



	-
	Ø3.5mm
	1:1
RPM max.	6'000

Bemerkung / Remarque / Note :

Adjustable $\pm 5^\circ$



E20-W20



	-
	-
	1:1
RPM max.	6'000

Bemerkung / Remarque / Note :

Adjustable $\pm 20^\circ$
 SCHWANOG 218135, Z=5, Ø6mm
 GLOOR 501-0003, Z=5, Ø6mm



Kühlung / Arrosage / Cooling:  INT Intern / Intérieur / Interior  EXT Extern / Externe / Exterior  Ohne / Sans / Without

STAR MICRONICS

- SR10J

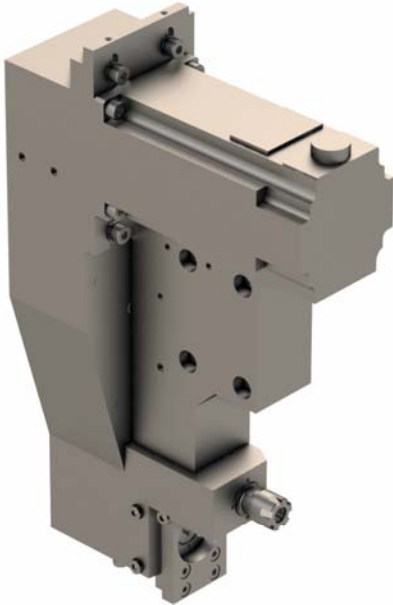
SR10J-GSC-E11S



	ER11
	-
	1:1.666
RPM max.	13'328

Bemerkung / Remarque / Note :

Original main block is to replace by this tool. To adjust the offset please contact your local Star Micronics dealer.
 Tool N°3100 are losted.
 Tool N°3200 in ER11 with RPM 13'328.
 Tool N°3300 is a modular quick change for different operation.



SR10J-GSC-E08



	ER08
	-
	1:1
RPM max.	8'000

Bemerkung / Remarque / Note :

-

SR10J-GSC-E11-2X





	2xER08
	-
	1:1
RPM max.	8'000

Bemerkung / Remarque / Note :

Offset second spindle : 4mm

Kühlung / Arrosage / Cooling:  INT Intern / Intérieur / Interior  EXT Extern / Externe / Exterior  Ohne / Sans / Without



SR10J-GSC-E11-2X-DEC

	2xER08
	-
	1:1
RPM max.	8'000

Bemerkung / Remarque / Note :

Offset seconde spindle : 0mm

SR10J-GSF-100-II

	-
	Ø10mm
	1:1
RPM max.	8'000

Bemerkung / Remarque / Note :

-



SR10J-GSF-080-II

	-
	Ø8mm
	1:1
RPM max.	8'000

Bemerkung / Remarque / Note :

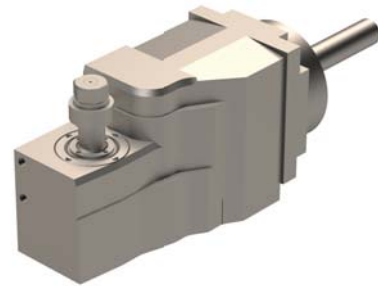
-

SR10J-GSH-035-II

	-
	Ø3.5mm
	1:1
RPM max.	8'000

Bemerkung / Remarque / Note :

-

 Kühlung / Arrosage / Cooling:  **INT** Intern / Intérieur / Interior  **EXT** Extern / Externe / Exterior  **Ohne / Sans / Without**

SR10J-GSH-050-II



	-
	Ø5mm
	1:1
RPM max.	8'000
Bemerkung / Remarque / Note :	
-	

SR10J-GSW-010



	-
	-
	1:1
RPM max.	8'000
Bemerkung / Remarque / Note :	
Adjustable $\pm 10^\circ$ Support made by PCM Willen SA, Z=5, Ø6mm	

SR10J-GSC-E11AZ

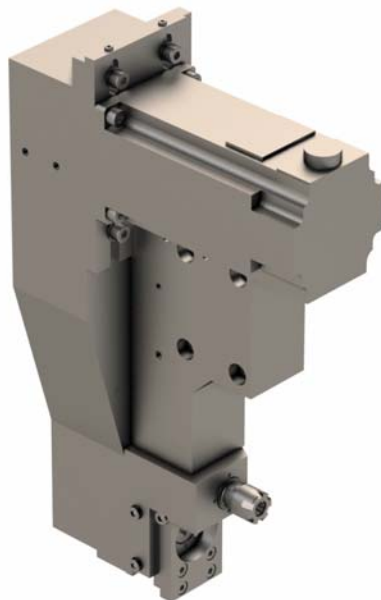

	ER11
	-
	1:1.666
RPM max.	13'328
Bemerkung / Remarque / Note :	

Original main block is to replace by this tool. To adjust the offset please contact your local Star Micronics dealer.
 Tool N°3100 are losted.
 Tool N°3200 in ER11 with RPM 13'328.
 Tool N°3300 is a modular quick change for different operation.
 Same construction as the SR10J-GSC-E11S but:
 The fixed spindle ER11 with RPM 13'328 are 8.7mm setback.
 The main block are 10mm longer.

Kühlung / Arrosage / Cooling: INT Intern / Intérieur / Interior EXT Extern / Externe / Exterior Ohne / Sans / Without

STAR MICRONICS

- SR20J

SR20J-GSC-010-HP

 INT

	ER16
	-
	1:1
RPM max.	8'000

Bemerkung / Remarque / Note :

Maximum 150 bar

SR20J-GSE-2310





	2x 3xER16
	-
	1:1
RPM max.	8'000

Bemerkung / Remarque / Note :

-

SR20J-GSE-010-HP

 INT

	ER16
	-
	1:1
RPM max.	8'000

Bemerkung / Remarque / Note :

Maximum 150 bar

SR20J-GSE-3710



	2x 3xER11
	-
	1:1
RPM max.	8'000

Bemerkung / Remarque / Note :

-

 Kühlung / Arrosage / Cooling:  INT Intern / Intérieur / Interior  EXT Extern / Externe / Exterior  Ohne / Sans / Without

SR20J-RSC-007



ER11



-



1:1

RPM max. 8'000

Bemerkung / Remarque / Note :

Maximum 150 bar

SR20J-W20

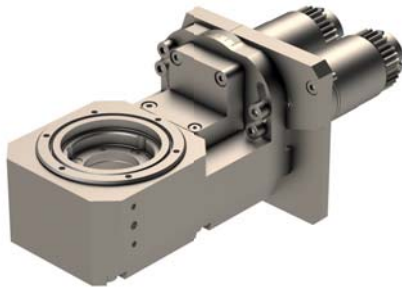

-



-



1:1

RPM max. 8'000

Bemerkung / Remarque / Note :

 Use 2 Locations
 Adjustable $\pm 20^\circ$
 SCHWANOG 191884, Z=6, $\varnothing 12\text{mm}$

 Kühlung / Arrosage / Cooling:  **INT** Intern / Intérieur / Interior  **EXT** Extern / Externe / Exterior  Ohne / Sans / Without

Kühlung / Arrosage / Cooling:  **INT** Intern / Intérieur / Interior  **EXT** Extern / Externe / Exterior  Ohne / Sans / Without

STAR MICRONICS

- SR32J

SR32J-GSE-3710



3xER16 + 3xER11



-



1:1

RPM max.

8'000

Bemerkung / Remarque / Note :

For STARMICRONICS SR32J



Kühlung / Arrosage / Cooling:  INT Intern / Intérieur / Interior  EXT Extern / Externe / Exterior  Ohne / Sans / Without

STAR MICRONICS

- SV20



SV20-901-AR

 I+E

	3xØ22
	-
	-
RPM max.	-
Bemerkung / Remarque / Note :	
-	



SV20-TSC-210



	2xER16
	-
	1:1
RPM max.	8'000
Bemerkung / Remarque / Note :	
-	



SV20-T2X2X4



	4xER11
	-
	1:4
RPM max.	24'000
Bemerkung / Remarque / Note :	
-	

SV20-TSE-010





	2x 2xER16
	-
	1:1
RPM max.	8'000
Bemerkung / Remarque / Note :	
-	

Kühlung / Arrosage / Cooling:  INT Intern / Intérieur / Interior  EXT Extern / Externe / Exterior  Ohne / Sans / Without

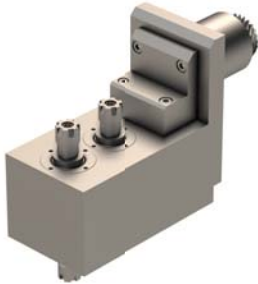
SV20-TSE-207



 2x 2xER11

 -

 1:1

RPM max. 8'000

Bemerkung / Remarque / Note :

-

SV20-W15



 -

 -



 1:1

RPM max. 8'000

Bemerkung / Remarque / Note :

Use 2 locations
Adjustable $\pm 15^\circ$
SCHWANOG 191884, Z=6, $\varnothing 12\text{mm}$

Kühlung / Arrosage / Cooling:  INT Intern / Intérieur / Interior  EXT Extern / Externe / Exterior  Ohne / Sans / Without



Kühlung / Arrosage / Cooling:  **INT** Intern / Intérieur / Interior  **EXT** Extern / Externe / Exterior  **Ohne / Sans / Without**

STAR MICRONICS

- SV32



SV32-TSC-210



	2xER16
	-
	1:1
RPM max.	5'000
Bemerkung / Remarque / Note :	
-	

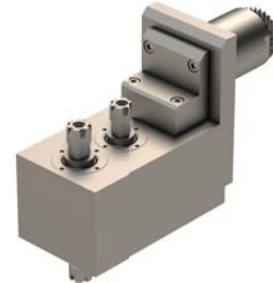

SV32-TSE-207



	2x 2xER11
	-
	1:1
RPM max.	5'000
Bemerkung / Remarque / Note :	
-	

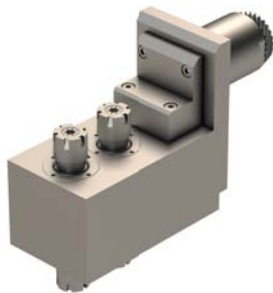

SV32-TSE-010



	2x 2xER16
	-
	1:1
RPM max.	5'000
Bemerkung / Remarque / Note :	
-	

SV32-W20



	-
	-
	1:1
RPM max.	5'000
Bemerkung / Remarque / Note :	
Use 2 locations Adjustable $\pm 20^\circ$ SCHWANOG 191884, Z=6, $\varnothing 12\text{mm}$	



Kühlung / Arrosage / Cooling:  INT Intern / Intérieur / Interior  EXT Extern / Externe / Exterior  Ohne / Sans / Without

STAR MICRONICS

- Quick change

STAR1-PCR



	-
	-
	1:1
RPM max.	6'000

Bemerkung / Remarque / Note :

Basis for STAR MICRONICS SW12-RII

STAR3-PCR



	-
	-
	1:1
RPM max.	6'000

Bemerkung / Remarque / Note :

Basis for STAR MICRONICS SR20J position T33

STAR2-PCR



	-
	-
	1:1
RPM max.	6'000

Bemerkung / Remarque / Note :

Basis for STAR MICRONICS SR20J position T34-35 and for STAR MICRONICS SB-12/16/20R

GSH-045



	-
	Ø4.5mm + Ø3.5mm
	1:1
RPM max.	6'000

Bemerkung / Remarque / Note :

Adjustable +15°/-3°
For STAR MICRONICS SW-12RII

Kühlung / Arrosage / Cooling:  INT Intern / Intérieur / Interior  EXT Extern / Externe / Exterior  Ohne / Sans / Without

GSH-145



	-
	Ø4.5mm + Ø3.5mm
	1:1
RPM max.	6'000

Bemerkung / Remarque / Note :

Adjustable +15°/-2°
 For STAR MICRONICS SB/SR20J

GSW-210



	-
	-
	1:1
RPM max.	6'000

Bemerkung / Remarque / Note :

Ajustable ±10°
 Special cutter head from PCM Willen SA, Z=5, Ø6mm

GSP-218



	-
	Ø8mm
	1:1
RPM max.	6'000

Bemerkung / Remarque / Note :

Maximum out Ø45mm
 Height 54.5mm

Kühlung / Arrosage / Cooling: INT Intern / Intérieur / Interior EXT Extern / Externe / Exterior Ohne / Sans / Without

Visit us online :
www.pcm.ch



PCM Willen SA

Route du Grammont 101
1844 Villeneuve
Switzerland

Tél. +41 (0)21 967 33 66
Fax: +41 (0)21 960 38 95